

energenie

GREEN ENERGY FOR OUR PLANET



EG-UPS-RACK-1000

EG-UPS-RACK-2000

EG-UPS-RACK-3000

USER MANUAL
HANDBUCH
HANDLEIDING
MANUEL DESCRIPTIF
РУКОВОДСТВО ПОЛЬЗОВАТЕЛЯ
КЕРІВНИЦТВО КОРИСТУВАЧА
INSTRUKCJA OBSŁUGI

Table of Contents

- 1 Safety Information.....11**
 - 1.1 UPS safety information.....11
 - 1.2 Battery safety information..... 11
- 2 Product Overview.....33**
 - 2.1 Specifications.....33
 - 2.2 Front panel features.....44
 - 2.3 Rear panel features..... 55
- 3 Installation.....66**
 - 3.1 Unpacking inspection.....66
 - 3.2 Installation information.....66
 - 3.3 Installation and output connection..... 77
 - 3.4 Standard Model Built-in Battery Pack Installation Guide..... 77
- 4 Network Functions.....99**
 - 4.1 Communication port.....99
 - 4.2 EPO port (optional)99
 - 4.3 Intelligent card (optional).....99
- 5 Operation.....1111**
 - 5.1 Button operation..... 1111
 - 5.2 Display interface..... 1111
 - 5.3 UPS On/Off operation.....1313
 - 5.4 UPS Settings.....1414
 - 5.5 Parameters inquiring operation.....1515
 - 5.6 Operation mode.....1616
- 6 Fault Messages.....1818**
- 7 Troubleshooting.....2222**
- 8 Software Download & Installation.....2424**

1 Safety Information

1.1 UPS safety information

- Read all safety information and operating instructions carefully before attempting to install, service or maintain the UPS. Save this manual properly for reuse.
- This UPS is intended for indoor use only.
- Do not operate this UPS in direct sunlight, in contact with fluids, or where there is excessive dust or humidity.
- Be sure the air vents on the UPS are not blocked. Allow adequate space against the wall for proper ventilation.
- Do not open the UPS case as you will, there is a high risk of electric shocks inside. All connection/wiring/servicing must be performed by a qualified electrician.
- Do not connect to the equipment like hair dryer or electric heater.
- Do not use liquid extinguisher if there is a fire, a dry powder extinguisher is recommended.

CAUTION













UPS has high voltage inside, do not repair it by yourself. If any questions, please contact local service center or dealer.

1.2 Battery safety information

- Environmental factors impact battery life. Elevated ambient temperatures, poor quality utility power, and frequent short duration discharges will shorten battery life. Replacing battery periodically can help to keep UPS in normal state and assure backup time required.
- Battery installing or replacing should be performed by a qualified electrician. If you want to replace the battery cable, please purchase it from our local service center or distributors to avoid fever and lighter which can cause fire by inadequate power capacity.
- Batteries may cause electric shocks and have a high short circuit current, follow below requirements before installing or replacing the batteries.
 - A. Remove wristwatches, rings, jewelry and other conductive materials.
 - B. Only use tools with insulated grips and handles.
 - C. Wear insulated shoes and gloves.
 - D. Do not put the metal tools or parts on the batteries.
 - E. Before disconnecting the terminals from the batteries, cut off all the loads to the batteries first.

- Do not dispose of the batteries with fire. The batteries may explode.
- Do not open or mutilate batteries. Released electrolyte inside is harmful to the skin and eyes, and maybe toxic.
- Do not connect the positive pole and negative pole directly, otherwise it will cause electric shocks or will be on fire.
- The battery circuit is not isolated from the input voltage, high voltage may occur between the battery terminals and ground, check if there is no voltage there before touching.

Note: Symbol instructions:

Symbol	Significations	Symbol	Significations
	Caution		Protective earth
	Danger! High Voltage!		Disable/mute audible alarm
ON	Turn on		Overload
OFF	Turn off		Battery inspection
	Standby or Shutdown		Repeat
	AC		Display screen repeat key
	DC		Battery

2 Product Overview

2.1 Specifications

Model	EG-UPS0-RACK-1000		EG-UPS0-RACK-2000		EG-UPS0-RACK-3000
Rated Capacity	1 kVA / 900W		2 kVA / 1800W		3 kVA / 2700W
Input					
Rated input voltage	208 Vac / 220 Vac / 230 Vac / 240 Vac				
Rated input frequency	50 Hz / 60 Hz (auto-sense)				
Input voltage range	110 ~ 176Vac (power derating linearly between 50% and 100% load); 176 ~ 280Vac (no derating); 280 ~ 300Vac (power derating 50%)				
Input frequency range	40~70 Hz				
PFC	≥ 0.99				
THDI	≤ 6%				
Bypass voltage range	-25% ~ +15% (settable)				
Output					
Output voltage	208 Vac / 220 Vac / 230 Vac / 240 Vac(settable)				
Voltage accuracy	± 1%				
Output PF	0.9				
Inverter overload capability	105% ~ 125% load: transfer to bypass in 1 min; 125% ~ 150% load: transfer to bypass in 30 s; > 150% load: transfer to bypass in 300 ms				
From mains mode to BAT mode	0ms (transfer time)				
From mains mode to bypass	4 ms (typical)				
Output frequency	Line mode	Same as input frequency			
	BAT mode	(50 / 60 ± 0.1) Hz			
Total voltage harmonic distortion	≤ 2% (linear load); ≤ 5% (non-linear load)				
Batteries					
Battery type	Sealed lead acid maintenance free battery				
DC voltage	24 V	36V	48 V	72V	72 V
Inbuilt battery	12 V / 9 Ah	12 V / 7 Ah	12 V / 9 Ah	12 V / 7 Ah	12 V / 9 Ah
Quantity	2	3	4	6	6

Charger output voltage	27.1± 0.4	40.6± 0.6	54.2± 0.8	81.3 ± 1.2	81.3 ± 1.2
Recharging time	Standard model: 90% capacity restored in 3 hours; Long time model: depend on the capacity of battery				
Charging current (Max.)	Standard model: 1 A				
System Control and Communications					
Protections	Over-temp protection; Fan testing protection; Overload protection; Output short circuit protection; Battery discharge protection				
Communication port	Standard: RS232; Options: USB, SNMP card, dry contacts				
Display	LCD+LED				
Environmental					
Operating humidity	0 ~ 95 % RH @ 0 ~ 40°C (non-condensing)				
Storage temperature	-25°C ~ 55°C(exclude batteries)				
Operating altitude	≤ 1000m, above 1000m, derate 1% for each rising 100m				
Protection class	IP20				
Noise level	≤50dB (at 1m)				
Others					
Dimensions (mm) W × D × H	440*316*88	440*430*88	440*430*88	440*560*88	440*560*88
Weight (kg)	10.6	15.5	18.7	25.6	26.8

* Derate capacity to 70% in CUCF mode and to 90% when the output voltage is adjusted to 208Vac.

Note:

Model	Type
EG-UPSO-RACK-1000	1 kVA Standard model
EG-UPSO-RACK-2000	2 kVA Standard model
EG-UPSO-RACK-3000	3 kVA Standard model

2.2 Front panel features

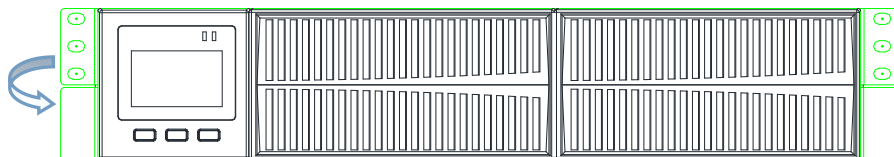

2.3 Rear panel features

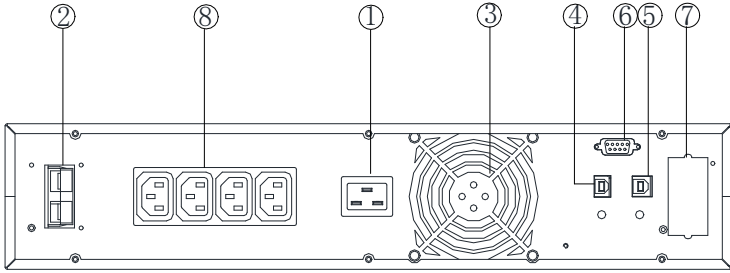

a. EG-UPSO-RACK-1000 (DC24V) rear panel

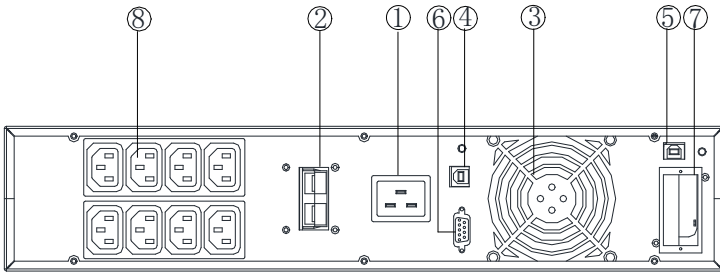

b. EG-UPSO-RACK-2000 (DC48V) rear panel

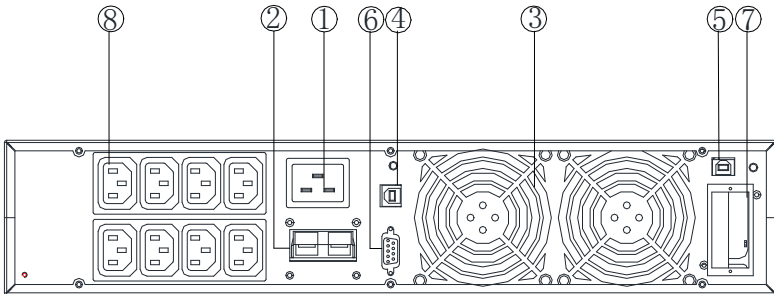

c. EG-UPSO-RACK-3000 (DC72V) rear panel

① AC input socket	⑥ RS232 port
② Battery connector	⑦ Intelligent slot
③ Fan	⑧ Output sockets
④ USB port	
⑤ EPO (Emergency Power Off) port	

Note:

The figure is for reference only. Due to the technology upgrading and development, the real unit might be different from the figure.

3 Installation

3.1 Unpacking inspection

- Open the UPS package and inspect the contents upon receipt. The accessories attached to the UPS contain a power cord, a user manual, communication cable, CD-ROM. The long backup model also includes the cable for connection to battery bank.
- Check if the unit is damaged during transport. Do not power on and notify the carrier and dealer if find damaged or parts missing.
- Verify this unit is the model you want to buy. Check the model name showed both on the front panel and rear panel.

Note:

Keep the packaging box and packaging materials for future transport use. The equipment is heavy. Always handle it with care.

3.2 Installation information

- The UPS installation environment must be in good ventilation, away from water, flammable gases and corrosive entities.
- Do not lie down the UPS against the wall so that front and side panel air intake hole, rear panel air outtake hole will be unobstructed.
- The ambient temperature around the UPS should be within 0°C~40°C (non-condensing) .
- If dismantling the machine at low temperatures, there may be condensation droplets, users can not install or operate it before UPS completely got dry both inside and outside, otherwise there will be danger of electric shocks.
- Place the UPS near the mains source so that can cut off utility power without any delay in case of emergency.
- Make sure the load connected to the UPS is off when users connect it to UPS, and then turn on the load one by one later.
- Connect the UPS with the power outlet which is over-current protected. Do not connect the UPS with power outlets whose rated current is less than the maximum input current of this UPS.
- All power outlets should be configured with earthing device for safety.
- UPS could be electrified or powered no matter the input power cord is tied or not, even when the UPS is off. The only way to cut off the output is switching off the UPS and disconnecting the mains power supply.

- For all standard model UPS, it is advised to charge the batteries over 8 hours before using. Once the AC mains power energizes the UPS, it will automatically charge the batteries. Without prior charging, UPS output remains as usual but with shorter back-up time than normal.
- When connected to motor, display equipment, laser printer etc., UPS power selection should be based on the startup power of the load which is usually twice as rated power.
- Wiring by a qualified electrician is required. Ensure input cables and output cables are connected correctly and firmly.
- If install a leakage current protective switch, please install it on output cable.

3.3 Installation and output connection

Normally, output connection of 1~3kVA series is configured with power outlets or terminal blocks, users can plug the load cable into the UPS power outlets to energize the load. Make sure the mains cable and breakers in the building are enough for the rated capacity of UPS to avoid the hazards of electric shock or fire.

3.4 Standard Model Built-in Battery Pack Installation Guide

Step 1 Make sure the UPS is in mains mode, remove the two plastic panels on the front.

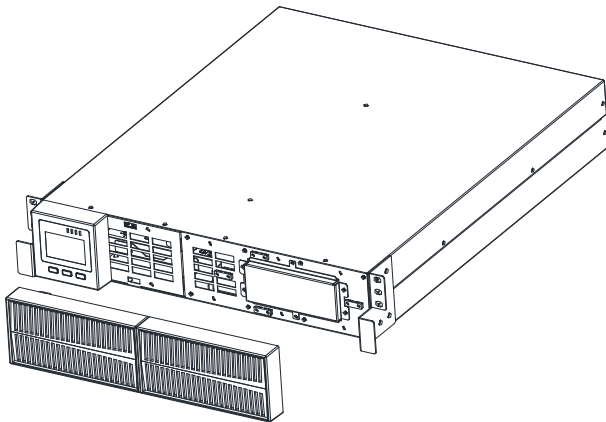

Step 2 Remove the two baffles in the picture below with a screwdriver.

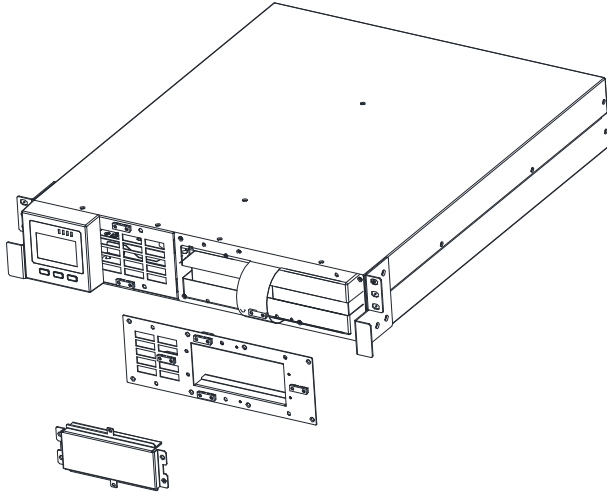

Step 3 Separate the battery terminals, pull the plastic handle of the battery pack, and drag the battery pack out.

Note: The battery pack is heavy. Please pay attention to safety when taking the battery pack to prevent foot injury.

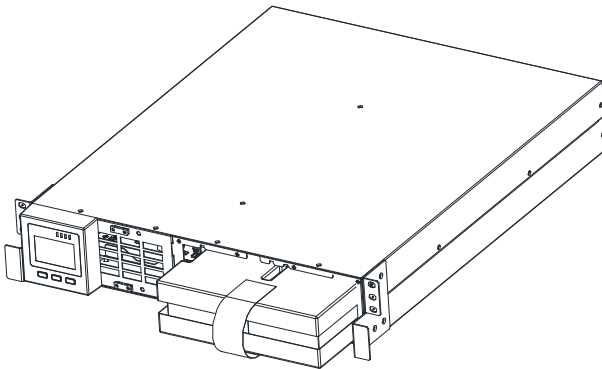

Step 4 After replacing the battery, put the battery pack back into the UPS. After connecting the battery terminals, lock the two baffles and cover the plastic panel.

4 Network Functions

4.1 Communication port

Users could monitor the UPS system through the communication port such as standard RS232 port and USB port with computer. Connecting this UPS with computer by communication cable could achieve UPS management easily.

>RS232 port:

Pins	1	2	3	4	5	6	7	8	9
Indication	empty	send	receive	empty	ground	empty	empty	empty	empty

Note:

RS232 interface is set as below:

- Bit rate: 2400 bps
- Byte: 8bit
- Completion code: 1 bit
- Bit pattern: None

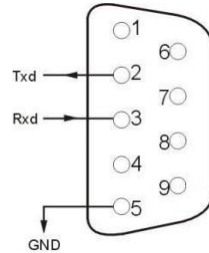

>USB port:

Pins	1	2	3	4
Indication	+5V	date+	date-	GND

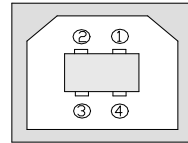

4.2 EPO port (optional)

EPO is the short for Emergency Power Off. EPO port is on the rear panel of the UPS. It's green. Users can cut off the output of UPS immediately by operating EPO port in case of emergency.

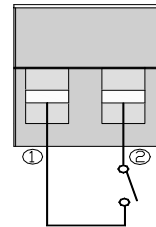

Normally, pin1 and pin2 are connected so that the machine can be working normally. When some emergencies happen, and when users have to cut off the output, just need to disconnect the connection between pin1 and pin2, or just pulling it out.

4.3 Intelligent card (optional)

There is an intelligent slot on the rear panel of the UPS, it's for SNMP card and dry contacts. Users can insert any type intelligent card from those three into it to monitor

and manage the UPS. And users don't have to turn off the UPS when install the intelligent card. Follow below process:

- First of all, remove the intelligent slot cover;
- Then insert the intelligent card (SNMP card and dry contacts);
- Finally, screw the intelligent card back.

> SNMP card (optional)

SNMP card on UPS is compatible with the most software, hardware and network operating system, it is a network management of UPS, with this function, UPS can login on internet , which can supply information of UPS status and input power, and even possible to control UPS via net management system.

> Dry contacts card (optional)

Insert the dry contacts card into the intelligent slot. It's another type function of intelligent monitoring.

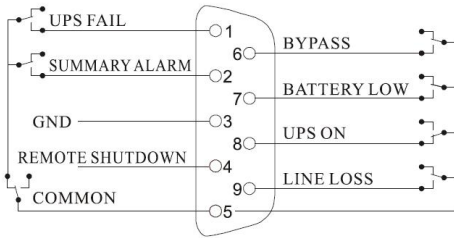

Position	Definition
PIN1	ON: UPS is malfunctioning
PIN2	ON: Alarm (system failure)
PIN3	Ground
PIN4	Remote shutdown
PIN5	Common
PIN6	ON: Bypass mode
PIN7	ON: Battery low
PIN8	ON: Inverter mode; OFF: Bypass mode
PIN9	ON: No AC power in







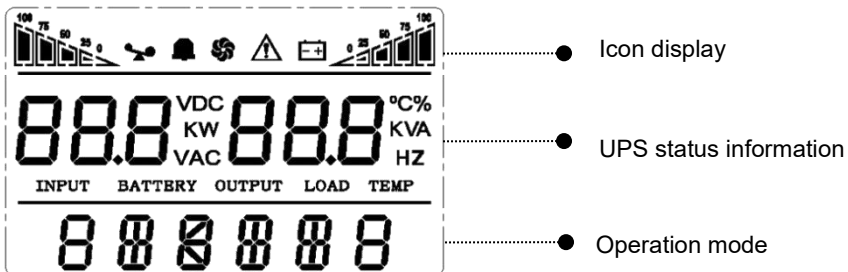

5 Operation

5.1 Button operation







Button	Function
“ON” key (← + ◀)	Press the two keys for more than half a second to turn on the UPS.
“OFF” key (◀ + ▶)	Press the two keys for more than half a second to turn off the UPS.
TEST/MUTE key (← + ▶)	Press the two keys for more than 1 second in Line mode or ECO mode or CUCF mode: UPS runs the self-test function. Press the two keys for more than 1 second in battery mode: UPS runs the mute function.
INQUIRING key (◀ , ▶)	Not in setting mode: <ul style="list-style-type: none"> • Press ◀ or ▶ for more than half a second (less than 2 seconds): display the items orderly. • Press ▶ for more than 2 seconds: Circularly and orderly display the items every 2 seconds, when press the key for some time again, it will turn to output status. In setting mode: <ul style="list-style-type: none"> • Press ◀ or ▶ for more than half a second (less than 2 seconds): Select the setting option.
FUNCTION SETTINGSkey (←)	Not in setting mode: <ul style="list-style-type: none"> • Press the key for more than 2 seconds: Function settings interface. In setting mode: <ul style="list-style-type: none"> • Press the key for more than half a second (less than 2 seconds): go to the function setting options. • Press the key for more than 2 seconds: exit from this function settings interface.

5.2 Display interface



Display	Function
Icon display	
	<p>Load icon: The approximate load capacity percentage (0-25%, 26-50%, 51-75% and 76-100%) is indicated by the number of load bar sections illuminated. When UPS is overloaded, the load icon will flash.</p>
	<p>Mute icon: Indicates the audible alarm is disabled / mute. Press the mute key in the battery mode, the mute icon flash.</p>
	<p>Fan icon: Indicates fan working status. When the fan normally runs, the icon displays rotation; if the fan is not connected or faulty, the icon will flash.</p>
	<p>Fault icon: Indicates UPS is in fault mode.</p>
	<p>Battery status icon: Indicates the battery capacity of 0-25%, 26-50%, 51-75%, and 76-100%. When the capacity of battery get low or battery disconnected, the battery status icon will flash.</p>
UPS status information	
	<ul style="list-style-type: none"> • In non-setting mode, it displays UPS output information when UPS normally runs; Fault code will be told in fault mode. • In setting mode, users could adjust different output voltage, activate ECO mode, activate CUCF mode, select an ID number and so on by operating function setting keys and inquiring key.
	
Operation mode	
	<p>Indicates the power capacity of UPS within 20 seconds after starting up. Indicates UPS operation mode in 20 seconds, such as STDBY (standby mode), BYPASS (Bypass mode), LINE (AC mode), BAT (Battery mode), BATT (Battery Self Test mode), ECO (Economic mode), SHUTDN (Shutdown mode), CUCF (Constant Voltage and Constant Frequency mode).</p>
LED indicator light functions	
	<p>They are respectively inverter light and fault light from left to right.</p> <p>The inverter light (green LED indicator light) illuminates continuously: it indicates that UPS is in mains mode or ECO mode or power supply status in battery mode.</p> <p>The fault light (red LED indicator light) illuminates continuously: it indicates that UPS is in fault status.</p> <p>Note: For LED indication in different modes, please refer to LED/display panel and alarm list.</p>

5.3 UPS On/Off operation

Operation	Description
Turn on the UPS	<p>> Turn on the UPS with mains power</p> <ul style="list-style-type: none"> ● With mains power connected, UPS works in bypass mode, its output is same as the input voltage within the input range. If there is no need of output voltage when mains power connected, you can set up bPS to 'OFF'. Default bPS is ON, it means there is bypass output when power on. ● Press the ON key for more than half a second to start the UPS, then it will start the inverter. ● Once started, the UPS will perform a self-test function. When the self-test finishes, it will turn to online mode. <p>> Turn on the UPS by battery without mains power</p> <ul style="list-style-type: none"> ● When main power is disconnected, press the ON key for more than half a second to start UPS. ● The operation of UPS startup process is almost same as above process with mains power. After the self-test finishes, UPS will work in battery mode.
Turn off the UPS	<p>> Turn off the UPS in Line mode</p> <ul style="list-style-type: none"> ● Press the OFF key for more than half a second to turn off the UPS. ● After UPS shutdown, there is no output. If output is needed, you can set BPS 'ON' on LCD setting menu. <p>> Turn off the UPS in battery mode without mains power</p> <ul style="list-style-type: none"> ● Press the OFF key for more than half a second to turn off the UPS. When UPS shutdown, it will do self-test first, until there is no display on the panel.
UPS self-test/mute test operation	<ul style="list-style-type: none"> ● When UPS is in LINE Mode, press the self-test/mute key for more than 1 second. UPS gets to self-test mode and tests its status. It will exit automatically after finishing test. ● When UPS is in BAT Mode, press the self-test/mute key for more than 1 second, the buzzer stops beeping. If you press the self-test/mute key for one more second, it will restart to beep again.
UPS Setting	<ul style="list-style-type: none"> ● Enter Setup interface. Press and hold the function setting key  for more than 2 seconds, then come to Setup interface, press and hold the inquiring key ( , ) for more than half a second (less than 2 seconds), select the function setting, choose the setup interface, at the moment, the letters flash. ● Enter the setup interface. Press and hold the function setting key  for more than half a second (less than 2 seconds), then come to the setup interface, at this time, the letters doesn't flash any more, the numerical value flash. Press and hold the inquiring key ( , ) for more than half a second (less than 2 seconds), select the numerical value in accordance with the function. ● Confirm the setup interface. After selecting numerical value, press and hold the function setting  for more than half a second (less than 2 seconds).

Now, the setting function is completed and the numerical value illuminates without flashing.

- Exit from the setup interface. Press and hold function setting key  for more than half a second (less than 2 seconds), exit from the setup interface and return to the main interface.

Note:

- UPS could not be set until it is connected to the battery and it is turned off and switched to StdbY mode (standby mode).
- Disconnect mains power after setting.
- The LCD display screen will automatically extinguish in about 1 min, and the setting will be configured normally.

5.4 UPS Settings

● Output voltage setting

LCD display	Settings
	<p>For 208/220/230/240 VAC models, you may choose the following output voltage:</p> <p>208: output voltage is 208Vac 220: output voltage is 220Vac 230 (default): output voltage is 230Vac 240: output voltage is 240Vac</p>

● Low voltage of battery setting

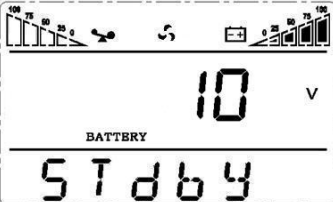
LCD display	Settings
	<p>The battery voltage selecting interface. You may choose the following output voltage:</p> <p>9.8: Low voltage of battery is 9.8Vdc 9.9: Low voltage of battery is 9.9Vdc 10: Low voltage of battery is 10Vdc 10.2: Low voltage of battery is 10.2Vdc 10.5: Low voltage of battery is 10.5Vdc dEF(default):EOD voltage automatically varies with loads, including 20 hours discharge protection</p>

● **Bypass mode setting**

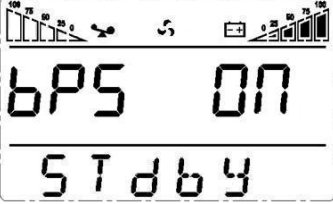

LCD display	Settings
	<p>Enable or disable Bypass function. You may choose the following two options:</p> <p>ON: Bypass enable</p> <p>OFF (default): Bypass disable</p>

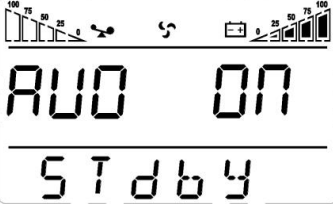
● **AUO setting**

LCD display	Setting
	<p>AUO setting only can be set in Stdby mode or Bypass mode. You may choose the following two options:</p> <p>ON: UPS will start up automatically and works in Line mode when connect mains.</p> <p>OFF (Default): UPS won't start up automatically when connect mains except EOD, it will work in standby or bypass mode.</p>

5.5 Parameters inquiring operation

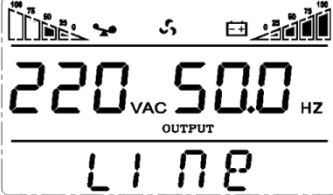

Press the inquiring key ◀ or ▶ for more than half a second (less than 2 seconds) to inquire about items. The inquired items include Input, Battery, Output, Load and Temperature. The displayed items on LCD screen are shown as following:

LCD display	Description
	<p>Output: Display the output voltage and output frequency of the UPS. As the following graphic shows, the output voltage is 220V, the output frequency is 50Hz.</p>
	<p>Load: Display the numerical value of the active power (WATT) and apparent power (VA) of the load. For example, as the following graphics shows, the WATT of the load is 800W, VA is 1.0kVA (when disconnect loads, it is a normal phenomenon to show a small numerical value of WATT and VA).</p>

	<p>Version and Temperature: Indicate firmware version of UPS and display the highest temperature of UPS components; As the following graphics shows, the firmware version is v1.7, the maximum temperature is 40°C.</p>
	<p>Input: Display the voltage and frequency of the input. As the following graphics shows, the input voltage is 220V, input frequency is 50Hz.</p>
	<p>Battery: Display the voltage and capacity of the battery. As the following graphics shows, the battery voltage is 24V, the capacity of battery is 100% (the capacity of battery is approximately reckoned according to the battery voltage).</p>
	<p>Warning: Display the warning code.</p>

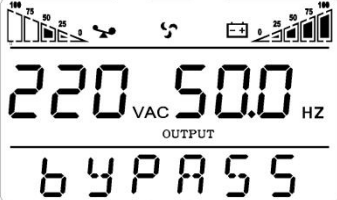
5.6 Operation mode

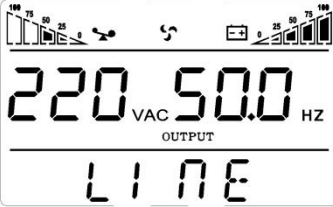
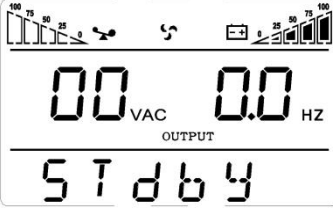
Operation mode and LCD display	Description
<p>Bypass mode</p> 	<p>Turn to bypass mode under the following three conditions:</p> <ul style="list-style-type: none"> ● Connect mains power and the bypass setup is ON. ● Turn off the UPS in line mode and the bypass setup is ON. ● Overload in line mode. <p>Note: When UPS is working in bypass mode, it has no back up function.</p>

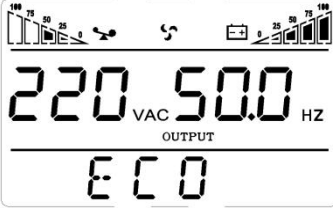
<p>Line mode</p>  <p>The LCD display in Line mode shows two rows of data. The top row displays '220 VAC 50.0 HZ' with 'OUTPUT' centered below it. The bottom row displays 'LINE'. Above the main display, there are two battery level indicators and a sine wave icon.</p>	<p>Being in line mode are as following: When input mains corresponding to the working conditions, UPS will work in line mode, LCD displays 'Line'.</p>
<p>Stdby mode</p>  <p>The LCD display in Stdby mode shows two rows of data. The top row displays '00 VAC 0.0 HZ' with 'OUTPUT' centered below it. The bottom row displays 'STdbY'. Above the main display, there are two battery level indicators and a sine wave icon.</p>	<p>UPS is powered off and no output supply power, but still can charge batteries.</p>
<p>Battery mode</p>  <p>The LCD display in Battery mode shows two rows of data. The top row displays '220 VAC 50.0 HZ' with 'OUTPUT' centered below it. The bottom row displays 'bAT'. Above the main display, there are two battery level indicators and a sine wave icon.</p>	<p>Being in battery mode are as following: the buzzer beeps once every 4 seconds. When the mains power is low or unstable, UPS will turn to battery mode at once, and LCD displays 'batt'.</p>
<p>ECO mode</p>  <p>The LCD display in ECO mode shows two rows of data. The top row displays '220 VAC 50.0 HZ' with 'OUTPUT' centered below it. The bottom row displays 'ECO'. Above the main display, there are two battery level indicators and a sine wave icon.</p>	<p>Being in ECO mode are as following: When the input mains meet the input range of the ECO mode and the ECO function is on, the UPS works in ECO mode. If input mains exceed the range of ECO several times within one minute but stays in inverter input range, UPS will work in inverting mode automatically. LCD displays 'ECO'.</p>

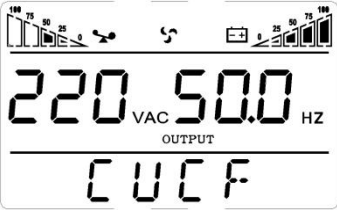
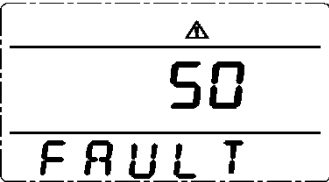
<p>CUCF mode</p> 	<p>Frequency conversion mode is mainly to provide a stable voltage and frequency (mainly in terms of frequency). After starting this mode, its output will not be affected by utility to meet input needs of some precision equipment and make users' load more stable and secure. After opening CUCF mode setup, LCD displays 'CUCF'. In CUCF mode, the loading capacity will drop to 70% of the original capacity. The output frequency is fixed at the setting value, it doesn't vary with utility change. And the UPS cannot be set to bypass mode in this mode.</p>
<p>Fault mode</p> 	<p>When UPS has a failure, the buzzer beeps and the UPS turns to fault mode. UPS cuts off the output and LCD displays fault codes. At the moment, users can press the mute key to make the buzzer stop beeping temporarily to wait for maintenance. Users can also press the OFF key to shut down the UPS when confirm that there is no serious fault.</p>

6 Fault Messages

Table 1: Fault code messages

Fault code	Fault type	Bypass output	Note
0、 1、 2、 3、 4	Bus high	yes	
5、 6、 7、 8、 9	Bus low	yes	
10、 11、 12、 13、 14	Bus unbalance	yes	
15、 16、 17、 18、 19	Bus soft start fail	yes	
20、 21、 22、 23、 24	Inverter soft start fail	yes	
25、 26、 27、 28、 29	Inverter high	yes	
30、 31、 32、 33、 34	Inverter low	yes	
35、 36、 37、 38、 39	Bus discharge fail	yes	
40、 41、 42、 43、 44	Over heat	yes	
45、 46、 47、 48、 49	Output short	no	
50、 51、 52、 53、 54	Overload	yes	
55、 56、 57、 58、 59	Bus short	yes	
60、 61、 62、 63、 64	Shutdown fault	yes	
70、 71、 72、 73、 74	Overload 5 times	yes	

Table 2: Working status messages

S/ N	Working status	LCD display messages	Alarm beep	LCD flashes	LED flashes	
					Invert er	Fault
1	Inverter mode (mains power)					
	Mains power voltage	Working mode displays Line	No beep	No flash	Flash always	/
	Mains power high/low voltage protection, switch to battery mode	Working mode displays bAT	One beep / 4 sec	One flash / 4 sec	One flash / sec	/
2	Battery mode					
	Battery voltage - normal	Working mode displays bAT	One beep / 4 sec	One flash / 4 sec	One flash / sec	/
	Warning for abnormal voltage of battery	Working mode displays bAT, Bat flash	One beep / sec	One flash / sec	One flash / sec	/
3	Bypass mode					
	Mains power – normal (under Bypass)	Working mode displays byPASS	One beep / 2 min	No flash	One flash / 2 sec	/
4	Warning for battery disconnected					
	Bypass mode	Working mode displays byPASS, bat display is 0, and flash all the time	One beep / 4 sec	One flash / 4 sec	One flash / 2 sec	/
	Inverter mode	Working mode displays Line, bat display is 0, and flash all the time	One beep / 4 sec	One flash / 4 sec	Flash always	/
	Power on / Switch on	LCD illuminates when power on, and display the capacity of the UPS, later working mode displays Line or byPASS, bat icon flash all the time	6 beeps	Flash always	Flash always	Flash always
					/	/
5	Output overload protection					
	Warning for mains power overload	Working mode displays Line, load icon flash	2 beeps / sec	2 flashes / sec	Flash always	/
	Protect operation for mains power mode overload	Working mode displays FAULT and the corresponding codes	Long beep	Flash always	/	Flash always
	Warning for battery	Working mode displays	2 beeps /	2	One	/

	overload	bAT, load iconflash	sec	flashes /sec	flash / sec	
	Protect operation for battery mode overload	Working mode displays FAULT and the corresponding codes	Long beep	Flash always	/	Flash always
6	Warning for bypass mode overload	Working mode displays byPASS, load iconflash all the time	One beep / 2 sec	One flash / 2 sec	One flash /2 sec	/
7	Fans fault(fan icon)	Fan icon flash, working mode displays depending on current mode	One beep / 2 sec	No flash	/	/
8	Faults mode	Working mode displays FAULT, numerical value area displays the corresponding error code	Long beep	Flash always	/	Flash always

Note:

- End user need to provide below information when require to maintain the UPS.
- UPS Model No. & Serial No.
- Date of fault occurrence.
- Fault details (LCD status, noise, AC power situation, load capacity, battery capacity configuration ect.)

Table 3: Alarm code display

The alarm code will be displayed in four digital tubes on the right of the numerical part of the LCD screen(red mark), as shown below:

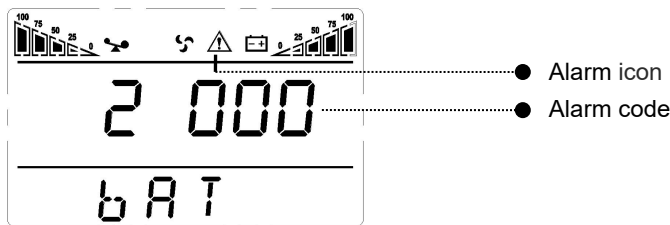

The alarm truth table during operations is shown as below:

• signifies the alarm occurs, blank signifies no alarm appears

The first digital tube from right to	Display value	Bypass lost	Remote Shutdown	Overload	Batterydisconnected
	0				

	1	•			
	2		•		
	3	•	•		
	4			•	
	5	•		•	
	6		•	•	
	7	•	•	•	
	8				•
	9	•			•
	A		•		•
	B	•	•		•
	C			•	•
	D	•		•	•
	E		•	•	•
	F	•	•	•	•
	Display value	Overcharging warnings	Mains reverse	Start-up abnormal	Charger fault
	0				
	1	•			
	2		•		
	3	•	•		
	4			•	
	5	•		•	
	6		•	•	
	7	•	•	•	
	8				•
	9	•			•
	A		•		•
	B	•	•		•
	C			•	•
	D	•		•	•
	E		•	•	•
	F	•	•	•	•
The second digital tube from right to left	Display value	EEPROM abnormal	Fan abnormal	Low battery	Median abnormal
	0				
	1	•			
The third digital tube from right to left	Display value	EEPROM abnormal	Fan abnormal	Low battery	Median abnormal
	0				
	1	•			

	2		•		
	3	•	•		
	4			•	
	5	•		•	
	6		•	•	
	7	•	•	•	
	8				•
	9	•			•
	A		•		•
	B	•	•		•
	C			•	•
	D	•		•	•
	E		•	•	•
	F	•	•	•	•
The fourth digital tube from right to left	Display value	Over load fault	Mains lost	Bypass abnormal	
	0				
	1	•			
	2		•		
	3	•	•		
	4			•	
	5	•		•	
	6		•	•	
7	•	•	•		

Example:

If the alarm code "2000" appears on the LCD screen, it indicates loss of mains power.

7 Troubleshooting

When the system works in fault mode, the LCD displays as below:

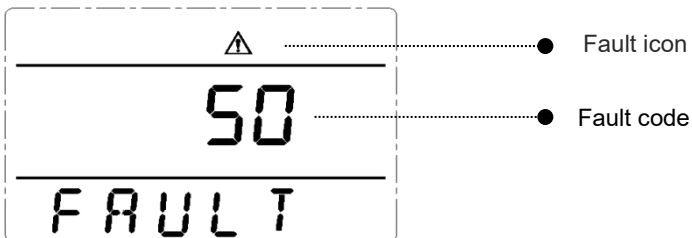

Problem	Possible Cause	Solution
Fault icon display, audible buzzer alarm continually, the fault code is 00-14	Bus voltage fault	Test the bus bar voltage or contact the supplier.
Fault icon display, audible buzzer alarm continually, the fault code is 15-24	Soft start fault	Check the soft start circuit, especially the input fuse or contact the supplier directly.
Fault icon display, audible buzzer alarm continually, the fault code is 25-39	Inverter voltage fault	Contact the supplier.
Fault icon display, audible buzzer alarm continually, the fault code is 40-44	Over heat	Be sure that the UPS are not overloaded, and the fan vent is not obstructed, as well as the indoor temperature is not high. Leave alone the UPS 10 minutes for cooling, and restart it. If the problem persists, contact the supplier.
Fault icon display, audible buzzer alarm continually, the fault code is 45-49	Output short	Turn off the UPS and disconnect all the loads. Be sure there is no any fault or internal short circuit of the loads. And then restart the UPS. If the problem persists, contact the supplier.
Fault icon display, audible buzzer alarm continually, the fault code is 50-54	Overload	Check the load level and disconnect the non-critical equipments, recount the total capacity of your load and reduce the load to the UPS. Check whether the load equipments has fault or not.
Fault icon display, audible buzzer alarm continually, the fault code is 55-59	Bus short	Contact the supplier.
Fault icon display, audible buzzer alarm continually, the fault code is 60-64	Shutdown fault	Check the first button of the LCD panel is pressed and cannot be bounced
Fault icon display, audible buzzer alarm continually, fan icon in the LCD flickers	Fan fault	Check whether the fans are connected and fixed well or not, and if fans are not broken. If all seems fine, contact the supplier.
UPS fail to start when operate 'On' key	Pressing time too short	Press the power key more than 2 seconds to start the UPS.
	The input connection is not ready or	Connect the input well, if the battery voltage is too low, disconnect the input

	UPS internal battery disconnect	and start the UPS with no-load.
	UPS internal system fault	Contact the supplier.
Back up time become short	Battery undercharge	Keep the UPS battery recharging more than 3 hours
	UPS overload	Check the load level and disconnect the non-critical equipments,
	Battery maturing, capacity descend	Replace with new batteries, contact the supplier to get the new batteries and spare parts.
UPS doesn't have any power going through even mains power on	UPS input breaker disconnected	Reset the circuit breaker by manual.

⚠ Note:

When the output is short-circuited, the action of UPS protection will show up. Before turning off the UPS, make sure to disconnect the entire loads and cut off the mains power supply, otherwise it will make the AC input shortcircuit.

8 Software Download & Installation

(Only for the model with communication port)

Please follow steps below to download and install monitoring software :

- 1 . Go to the website <https://www.idbkmonitor.com>
- 2 . Click UPSSmartView software icon and then choose your required OS to download the software
- 3 . Follow the on-screen instructions to install the software

